

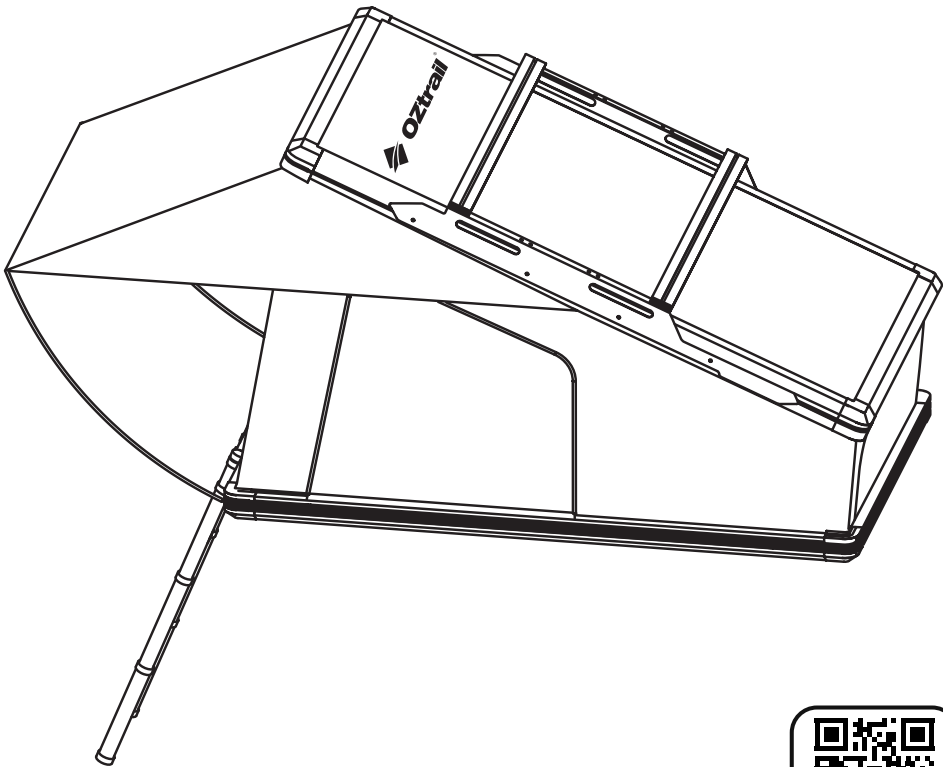

## OWNERS MANUAL

# Canning 1300

10000710



SCAN QR CODE  
FOR SET UP AND  
PACK DOWN  
VIDEOS.

# MOUNTING CONTENTS

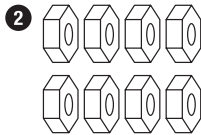
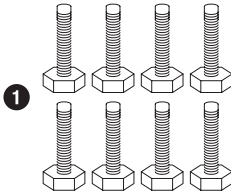

- 1. 45MM STEEL BOLT
- 2. M8 NYLOCK NUT
- 3. STEEL MOUNT PLATE
- 4. ALUMINIUM SLIDE PLATE

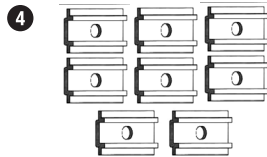
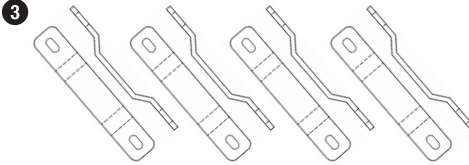

- 5. 16MM STAINLESS STEEL WASHERS
- 6. 10MM & 13MM WRENCH
- 7. HEX KEY

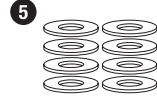

# SAFETY INFO AND MOUNTING INSTRUCTIONS

## WARNING

Incorrect installation or use of your roof top tent could result in serious injury or death. Follow the installation instructions to ensure the roof top tent is installed correctly. Follow the set up and pack down instructions carefully. It is recommended that you contact your vehicle and/or accessory manufacturer for specified loading and capacity of your vehicle's roof capacity and the rack capacity. Unfortunately, not all vehicles and roof racks can safely accommodate all models.

## LOCATE MOUNTING LOCATIONS ON ROOF RACK

OZtrail® recommends this roof top tent to be installed with minimum 4 people. It is also recommended to use an experienced aftermarket 4X4 accessories fitter to mount the roof top tent to your rack.



**PROLONGED TRAVELLING ON UNEVEN, ROUGH OR CORRUGATED TERRAIN WILL REQUIRE MORE FREQUENT INSPECTIONS**

**NOTE: OZtrail® takes no responsibility for the fitment of the roof top tent to any vehicle or roof rack.**

## MOUNTING TENTS TO ROOF RACK

These brackets have been carefully designed to fit most common roof rack configurations. However, the increasing amount of roof rack designs available in the market makes it

difficult to supply a bracket to fit all racks. It is recommended to discuss specific mounting options and load capacities with a roof rack specialist. There may be a chance you need to purchase aftermarket roof top tent mounts from your roof racks manufacturer for customised set ups.

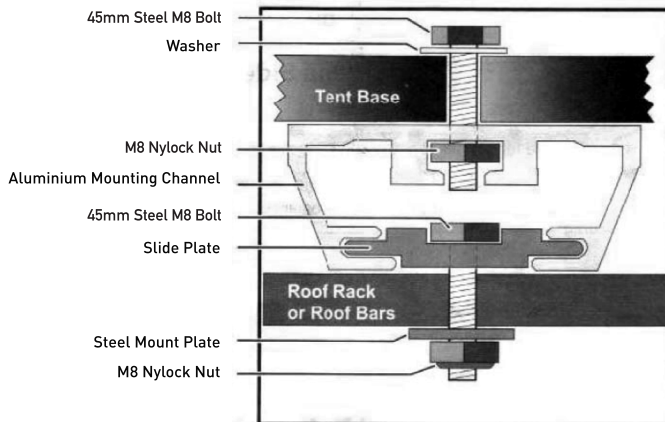

## USING YOUR LADDER

Do not use the ladder before reading the below points. For your own safety and to avoid any potential injury, ensure that the ladder placement and angle is correct. Review the below diagram showing the correct angle to position the ladder. Failure to do this may result in injury. To achieve the correct angle, you may need to adjust the ladder's length. If this is required, the adjustment must be done from the top of the ladder. Ensure the ladder is fully extended and all rungs are locked into place. Once this is done, press the first set of locking buttons positioned second rung from the top. The ladder will then compress until a gap of approximately 1-2cm is achieved between rung 1 and rung 2. If further shortening is required, press the second set of locking buttons which

is positioned on the third rung of the ladder. This will then close the previous gap between rung 1 and rung 2. Swing in the bottom of the ladder until the desired angle is reached. Review the below diagram before using the ladder.

The ladder also acts as extra support and a brace for the roof top tent when in use.

Please note: Review the measurement between where the ladder will sit on your car and the ground before use. If this exceeds the maximum length of the supplied ladder, you may need to purchase an aftermarket ladder to reach this length.

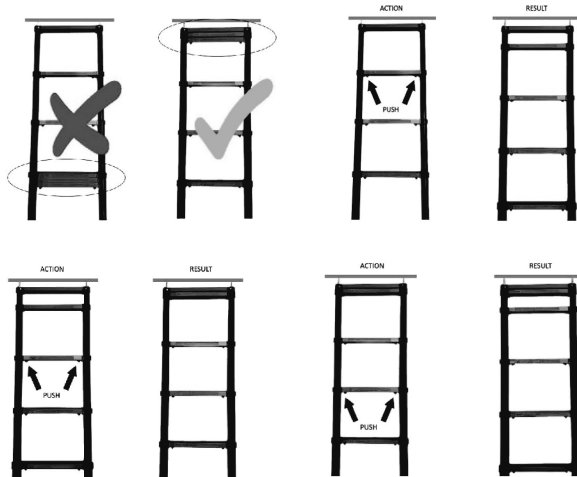
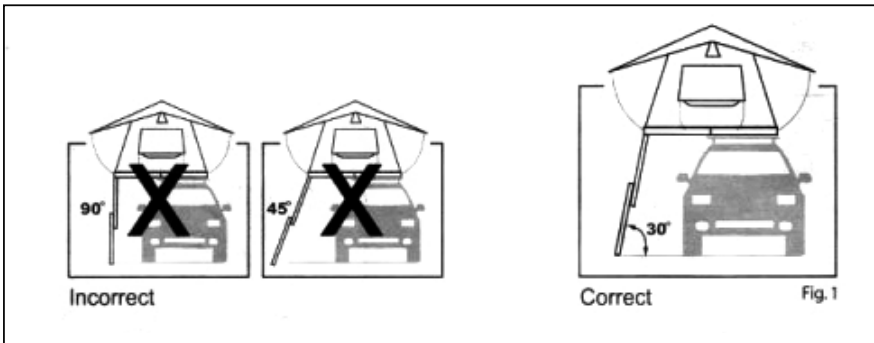

## FITTING THE TENT TO YOUR ROOF RACK

1. Place the roof top tent on top of your roof rack system (minimum 4 people required).
2. Place the 45mm steel M8 bolts into the slide plates ready for installation into the mounting channels. Slide the plates into positions either side of the roof rack system's bars.
3. Check the position of the roof top tent and ensure that it's in the correct place.
4. Tighten the nylock nuts with the supplied metal plate on all four positions as per the below diagram. Please note: It is important to regularly check all the mounting hardware to ensure they are securely attached to both the base of the tent and the roof rack system.

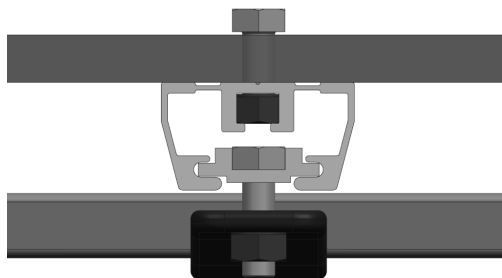
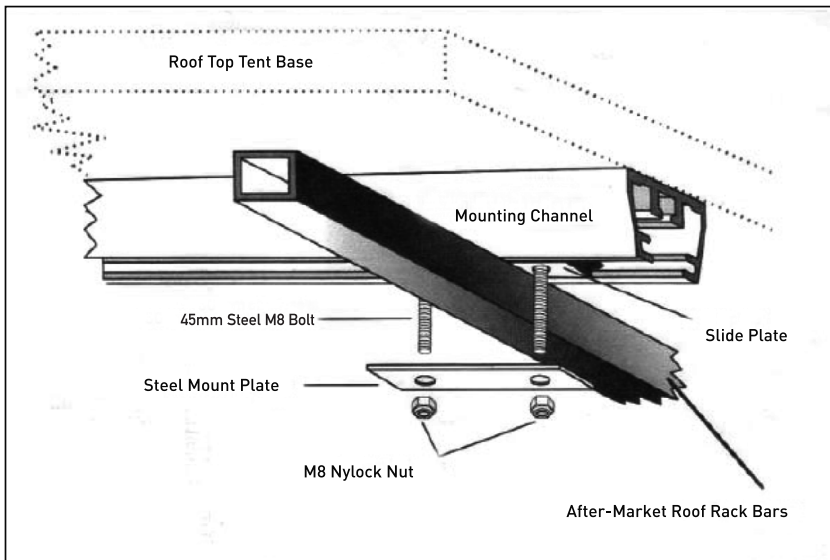

## CLEANING

Clean with cold water and a soft bristle brush. Do not use soaps or detergents. Do not expose to petrol, diesel, oils or chemicals of any nature.

Failure to follow these instructions may impact the performance of your roof top tent and cause damage.

## STORAGE

If you have to pack your roof top tent up wet - it is essential that the roof top tent is unpacked and allowed to dry fully as soon as possible. Failure to do so will result in damage to the roof top tents fabric, waterproofing and may cause mildew.

Although the cover material itself is waterproof, there is a chance of water ingress from the zippers and seals when the roof top tent is stored. We recommend to check the inside of the roof top tent bag to ensure no water has made its way in. If there is moisture, the roof top tent needs to be allowed to dry out.

## STRUCTURE

OZtrail® roof top tents have been designed for general outdoor use under normal conditions. Always ensure that all ropes and pegs are attached and is secured at all times.



**To avoid chances of personal injury and or property damage, OZtrail® highly recommends the roof top tents should NOT be erected during windy conditions.**

**Damage caused by wind and/or adverse weather will not be covered under warranty.**

## FITTING

OZtrail® recommends this roof top tent to be installed with minimum 4 people. It is also recommended to use an experienced aftermarket 4X4 accessories fitter to mount the roof top tent to your rack. All mounting hardware on both the roof top tent and roof rack should be checked regularly to ensure they are always mounted securely.



**NOTE: OZtrail® takes no responsibility for the fitment of the roof top tent to any vehicle or roof rack.**

**Prolonged travelling on uneven, rough or corrugated terrain will require more frequent inspections.**

The brackets have been carefully designed to fit most common roof rack configurations. However, the increasing amount of roof rack designs available in the market makes it difficult to supply a bracket to fit all racks. It is recommended to discuss specific mounting options and load capacities with a roof rack specialist.

## WATERPROOFING

The raw materials that have been used on this roof top tent have been designed to withstand most weather events. The water repellent coating and sealed seams provide protection from bad weather. However, wind-driven rain can cause water ingress when windows and doors are open. We recommend to close all windows and doors in the case of bad weather. If you find that water is coming through a zipper, a softened wax stick can be used to rub over that area.

**Disclaimer:** Any addition applied onto the vehicle's roof changes the loading and handling of the vehicle. OZtrail® disclaims all responsibility in the occurrence of accidents due to improper use, lack of maintenance and not ensuring the roof top tent has been securely fitted. OZtrail® shall not be liable for any damages whether they are special, indirect, incidental, accidental or consequential.

## SAFETY WARNINGS



**KEEP ALL FLAME AND HEAT SOURCES AWAY FROM THE FABRIC.**

**UNDER NO CIRCUMSTANCES SHOULD ANY NAKED FLAME SOURCES BE USED NEAR THE ROOF TOP TENT.**

**KEEP CAMP FIRES AWAY FROM THE ROOF TOP TENT.**

**KEEP A FIRE EXTINGUISHER OR WATER BUCKET NEARBY. WATCH FOR AIRBORNE BURNING EMBERS THAT MAY COME INTO CONTACT WITH THE ROOF TOP TENT OR ANNEX.**

**KEEP EXITS CLEAR.**

**IT IS ESSENTIAL TO USE ALL POLES, ROPES AND PEGS AT ALL TIMES WHEN THE TENT IS IN USE.**

**WATCH FOR GUY ROPES, PEGS AND STRAPS TO PREVENT INJURY AS THEY CAN BE A TRIP HAZARD.**

**ENSURE CHILDREN ARE SUPERVISED AROUND THE ROOF TOP TENT AT ALL TIMES.**

**DO NOT OPERATE ANY DEVICE WHICH BURNS FUEL INSIDE THE TENT OR ANNEX.**

## WARRANTY

Adventure Trading Australia P/L warrants this product against defects for a period of three years from the date of purchase. Adventure Trading Australia P/L will repair or replace the product, at its discretion, should a warrantable defect arise within the warranty period. If the exact model is unavailable a model of equivalent nature will be substituted at our discretion. This warranty excludes faults and failures caused by improper use and abuse; fair wear and tear; or failure to follow instructions regarding care and maintenance. Products used for a commercial nature are not covered by this warranty against defects. A warranty may be claimed by returning the product to its place of purchase, with a detailed proof-of-purchase clearly showing the date and detail of the purchase or contacting Adventure Trading Australia P/L directly.

You can contact Adventure Trading Australia P/L Customer Service by phone on 1300 555 197, in writing: PO Box 1110, Eagle Farm QLD 4009. The benefits under Adventure Trading Australia P/L warranty against defects are in addition to other rights and remedies under law in relation to goods

Our goods come with guarantees that cannot be excluded under the Australian Consumer Law. You are entitled to a replacement or refund for a major failure and for compensation for any other reasonably foreseeable loss or damage. You are also entitled to have the goods repaired or replaced if the goods fail to be of acceptable quality and the failure does not amount to a major failure.

For more detailed information and an explanation of these terms see [www.oztrail.com.au/warranty](http://www.oztrail.com.au/warranty) or email [warranty@adventureoperations.com](mailto:warranty@adventureoperations.com)



OZtrail® is a registered trademark of  
**Adventure Trading Australia Pty Ltd**

Designed by  
**Adventure Trading Australia Pty Ltd**  
71 Charles Ulm Place,  
Eagle Farm, QLD 4009  
AUSTRALIA

Made in China

